



SCRAP LIFTING MAGNET

INSTALLATION AND OPERATIONS MANUAL

P.O. #: Order #: Part #:

INTRODUCTION

Thank you for purchasing this IMI Walker Magnetics Product. If used and maintained properly, it should serve for many years. Thousands of IMI Walker lift magnets are in service today performing safe, fast, and efficient magnetic material handling applications.

IMI Walker Magnetics Products have proven to be among the best designed and safest in the industry. Note that if used improperly, any Scrap magnet can be rendered inefficient and unsafe. It is essential that anyone who uses this lifting magnet and is responsible for its application be trained on how to use it correctly.

READ THIS MANUAL CAREFULLY TO LEARN HOW TO OPERATE AND MAINTAIN THE MAGNET. FAILURE TO DO SO COULD RESULT IN SERIOUS INJURY TO OPERATORS AND PEOPLE IN THE AREA.

THIS MANUAL SHOULD BE CONSIDERED A PERMANENT PART OF THE MAGNET AND SHOULD ALWAYS BE AVAILABLE TO ALL OPERATORS AND REMAIN WITH THE MAGNET IF IT IS RE-SOLD.

IMI Walker Scrap Series magnets have been designed specifically to fit the needs of scrap processing operations. From 48" to 72" diameter, magnet sizes and weights have been selected to maximize the lifting capabilities of standard scrap handling cranes. The high lift-to-weight ratio of these magnets allows the movement of more and heavier scrap.

The Scrapmaster Series magnet has a rugged ribbed case, heavy manganese steel bottom plate, welded watertight construction and tough alloy steel chains for maximum durability. Scrapmaster magnets can be configured in either cylindrical or dish style die construction.

The LiftMaster series are ideal for the railroad industry for track sweeping and other metal lifting operations due to their ease of use, cost-effectiveness, low weight, and minimal maintenance requirements.





INTRODUCTION

The Scrap Lifting magnet systems can be engineered and supplied complete with power supply, controls and battery back-up. Scrapmaster and Liftmaster magnets are operated by magnet controllers which may be customer-supplied or purchased as part of a system from IMI / Walker.

FEATURES:

- » Low-carbon steel body for maximum magnetic performance
- » Heavy-duty, fully moisture-protected coils wound for 50% duty cycle
- » Coiled cord and twist lock adapter for quick connection to DC power source (magnet controller required)
- » Mating twist lock receptacle provided for installation convenience

OPTIONS INCLUDE:

- » High strength steel bails
- » Magnet controller

This manual covers the following standard products:

SCRAPMASTER D SERIES	SCRAPMASTER DISH SERIES	LIFTMASTER SERIES
WSMD048B41	WSMH045B41	WLM030B41
WSMD057B41	WSMH054B41	WLM040B41
WSMD066B41	WSMH063B41	
WSMD072B41	WSMH069B41	

All of the above are standard 230 volt DC, Class H insulated. Coils are encapsulated in a high dielectric strength, moisture resistant, resilient compound with a heavy manganese bottom plate. Inner and outer poles are hard-faced with an abrasive resistant layer of weld to retard wear.

CONTENTS

INTRODUCTION	1
SAFETY INSTRUCTIONS	3
INSTALLATION INSTRUCTIONS	5
GENERAL OPERATING INSTRUCTIONS	8
IMPORTANT FACTS FOR THE OPERATION OF LIFT MAGNETS	9
TROUBLE SHOOTING	11
LIFTING GUIDELINES and SPECIFICATIONS	13
DUTY CYCLE	14
PARTS LIST	14
INSPECTION AND MAINTENANCE	15
REPAIRS	16

ASME B30.20 Below-the-Hook Lifting Devices Safety Standard

IMI-Walker Lifting magnets have been designed and manufactured in accordance with ASME B30.20 Below-the-Hook Lifting Devices Safety Standard and the associated BTH-1 Design of Below-the-Hook Lifting Devices Standard. These American National Standards cover the design, construction, testing and labeling of Close Proximity Operated Lifting Magnets and Remotely Operated Lifting Magnets.







SAFETY INSTRUCTIONS



RECOGNIZE SAFETY INFORMATION

The following indications are provided as alerts to special considerations:

 DANGER	DANGER indicates a hazardous situation which, if not avoided, will result in death or serious injury.	<i>These Hazard Signal Words Deserve your Full Attention</i>
 WARNING	WARNING indicates a hazardous situation which, if not avoided, could result in death or serious injury.	
 CAUTION	CAUTION indicates a hazardous situation which, if not avoided, could result in minor or moderate injury.	

Follow these simple rules to avoid lifting incidents:



Never attempt to use this magnet until this manual has been reviewed and understood.

Always make sure that the supporting structure and load attaching devices (i.e. crane, chains and hook) are rated to support the weight of the magnet and load.

Always make sure that the load's weight and dimensions are within the Magnet's Lifting Guidelines. These Guidelines are located in this Manual.



Never use this magnet to lift or transport people.
Never lift more than one workpiece at a time with this magnet.



Never lift loads over people or in close proximity to people.
Never leave any lifted load unattended.



Always stay clear of the load.
Always let those nearby know that a lift is to begin.



Please be advised that in and around the application of magnetic equipment, there are potential safety concerns that can arise with sensitive medical devices:



- » Pacemaker behavior can be affected when they are near strong magnetic fields
- » Medical implants and external fixation systems can be influenced by magnetic fields
- » Hearing aid behavior may be affected when exposed to strong magnetic fields

Any individual that carries the above equipment or other sensitive medical devices should use caution when they are around or handling magnets. For more specific information the wearer should contact their physician.



Beware of pinch points from sudden attraction and unexpected movement between magnets and ferrous metal equipment components or tools.



SAFETY INSTRUCTIONS (CONTINUED)

Danger always exists when loads are transported by lifting devices, especially when the equipment is not being used properly or is poorly maintained. Special safety precautions apply to the operation, inspection, and maintenance of the Walker Lift Magnets.

Proper lifting knowledge and techniques are the responsibility of the operator. Be sure to read and understand the instructions and safety warnings contained in this manual before using the magnet.

TO AVOID A REDUCTION OF LIFTING CAPACITY

DANGER

To Avoid a Reduction of Lifting Capacity:

- » The lifting surfaces of the magnet must be clean, smooth, flat and free of nicks and burrs.
- » The full area of the magnet's lifting surface must be in contact with the load.
- » The temperature of the magnet and/or the load must not be greater than 110°F (43°C).
- » Repair of this magnet should only be performed by IMI Walker Magnetix or a Qualified (Designated) Person.**
- » The control actuator must be fully in the "on" or "lift" position
- » Do not exceed the magnet duty cycle. Exceeding the duty cycle will result in reduced lifting capacity.

ADDITIONAL WARNINGS

WARNING

- » Never operate damaged or malfunctioning magnets.
- » Never operate a magnet with a direct electrical short to the magnet case - this presents a severe shock hazard.
- » Electrical power interruption to electromagnets may cause the load to drop with a risk of injury to anyone in close proximity. Note that ElectroPerm magnets are not affected by electrical power interruptions once they have been turned on and fully charged.
- » Never remove or damage Operating and Warning labels.
- » If the magnet was provided with a remote control unit, NEVER place the control unit in a position where the switch could be accidentally activated to "RELEASE" or "GRIP".
- » Disassembly or repair of this magnet can result in reduced holding power and/or cause an unsafe condition. Anytime the magnet is disassembled beyond the parts list shown in this manual, the magnet must be re-tested for breakaway force in accordance ANSI/ASME B30.20.
- » Never connect or disconnect a magnet when the power is on.

SAFETY PERSON

Walker Magnetix recommends that a person be assigned to review all magnetic handling applications for these magnets to ensure that safe practices and procedures are being followed.

* Walker replacement parts may be installed by a **Designated Person.

** Designated Person: A person selected or assigned by the employer as being competent to replace specific replacement parts listed in this manual and able to verify proper functioning of the specific replacement parts and the entire product after the completion of the installation.



INSTALLATION INSTRUCTIONS

BEFORE INSTALLING THE SCRAP MAGNET

1. Unpack the scrap magnet and/or magnet system and check that all components have been included and are undamaged after shipment.
2. Observe all instructions and warnings in this manual and on the scrap magnet.
3. Check that the load rating of the hoisting equipment exceeds the total weight of the load plus the weight of the scrap magnet.
4. If the scrap magnet is to be installed on an existing crane, hoist, or other type hoisting equipment, move it to a location where it will cause the least interference with other equipment and operations in the area.
5. Place all power controllers in the **"OFF"** position.



Prior to beginning installation, check that all sources of power are disconnected, locked out, and tagged "out of service"

All electrical wiring should be installed by a qualified electrician and must conform to national, state /province and local electrical codes.



Determine the voltage and current rating of the magnetic lifter. This information is marked on the magnet or system's nameplate.

ELECTRICAL POWER DISCONNECTS

- » A separate Magnet circuit disconnect switch is required, independent of the hoisting equipment's disconnect switch.
- » The disconnect switch must be of the enclosed type with provision for locking, flagging, or tagging in the open (off) position and have means for discharging the inductive energy of the magnet.
- » The Magnet circuit disconnect switch must be connected on the line side (power supply side) of the hoisting equipment disconnect switch.
- » Power supplied to magnets from DC Generators can be disconnected by disabling the external powered source connected to the DC generator, or by providing a circuit switch that disconnects power to the generator and removes all power to the magnet.
- » Disconnects are not required on externally powered electromagnets operating from a 120 V AC power source.

ELECTRICAL GROUNDING



All IMI Walker scrap magnets are provided with provisions to ground the electrically conductive body of the magnet in order to facilitate compliance with governing electric codes.

- » It is the responsibility of the electrical installer to verify that the magnet is electrically wired and grounded properly and in accordance with the local and national electric code for the intended application.
- » In the USA, the governing national standard is the National Electric Code NFPA 70. Article 250 contained in this code is devoted to the grounding requirements for various types of installations.
- » Prior to energizing the electromagnetic device, check all the electrical connections and confirm that the metal body of the electromagnetic device is electrically grounded.



INSTALLATION INSTRUCTIONS (CONTINUED)

GENERATOR

Connections on generator are shown below for C.C.W. rotation facing commutator end. Interchange field connections for clockwise rotation.

Eliminate control panel by connecting F2 to A2. Voltage will then be controlled by generator RPM only.

TYPICAL GENERATOR SCHEMATIC

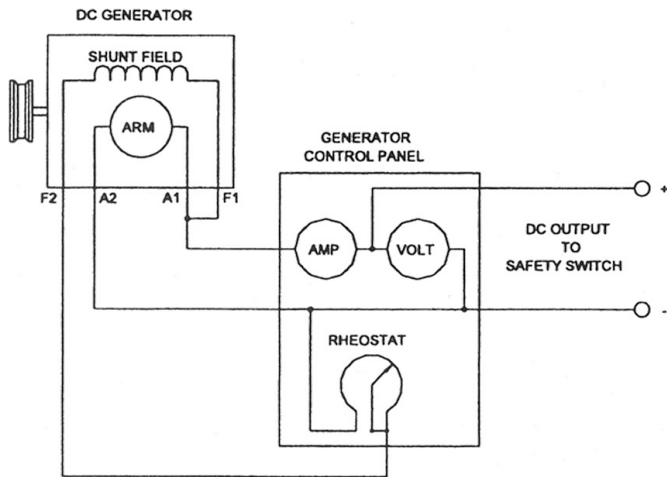

RECTIFIER

Rectifier must be rated for magnet service and be equipped with surge protection.

Rectifier may have options such as AC circuit breaker, AC line contractor, DC metering, indicator lights, fuses or circuit breakers, which are not shown below.

TYPICAL RECTIFIER SCHEMATIC

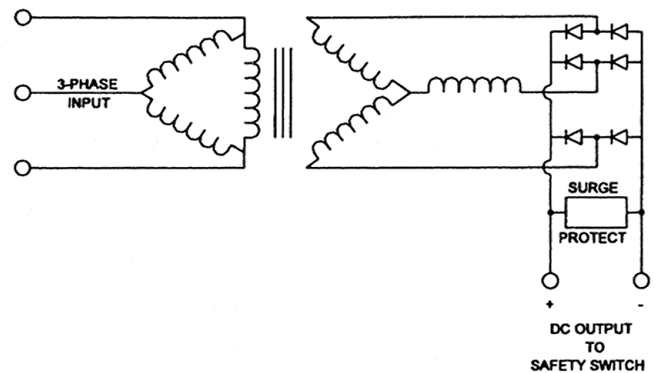

MAGNET SUPPRESSION

When energized, an electromagnet creates a large magnetic field and the magnet coil contains large amounts of energy. When the current producing source is removed from the magnet coil, capacitive discharging occurs and the coil dissipates its energy internally.

IMI Walker employs a suppressor/resistor network across the magnet to control the stored energy in the magnet coil.

If a control other than an IMI Walker unit is to be used, ensure that the controller provides adequate suppression. Adequate suppression is defined as any circuit which provides a continuous current path. For technical assistance, contact your IMI Walker representative.



INSTALLATION INSTRUCTIONS (CONTINUED)



Always use a Safety Hook Latch to secure the magnet to the crane hook



CABLE TAKE UP REEL

A cable take-up reel is recommended on boom type and overhead type cranes to control the cables in the air between the crane and magnet. Cable take-up reels are not normally required on hydraulic type cranes.

CABLE STRAIN RELIEF

Cable strain reliefs are recommended for all applications to eliminate strain on terminal connections. With electrical power off, connect power supply cable to the line side terminals of connectors. Power supply cable should be supported in a vertical position to prevent cable damage. Recommended installations are illustrated below.

ESTABLISH TEST VALUES

To obtain accurate values for future test reference, the Coil Resistance Test, Megger Test, and AC Current Test should be performed on a magnet immediately upon receipt from the manufacturer. The values obtained from these tests should be recorded and compared with subsequent tests results.

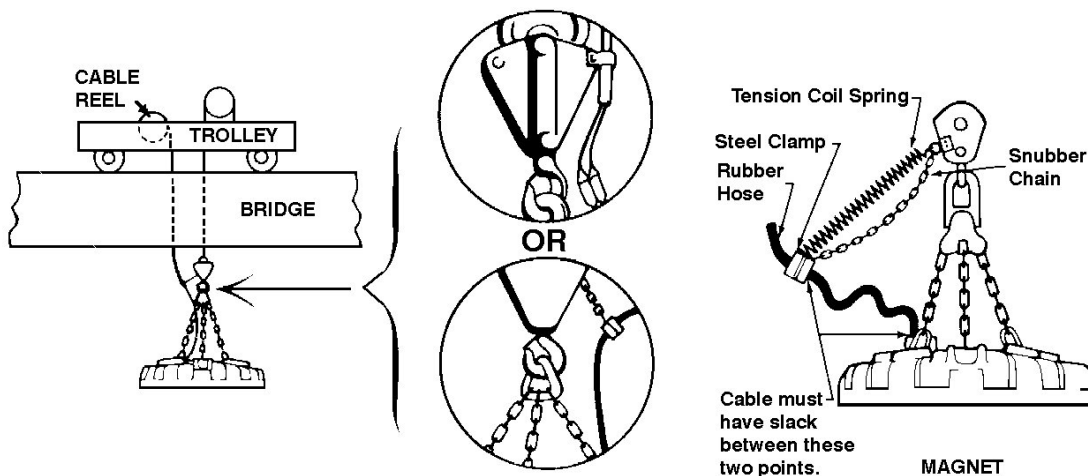



GENERAL OPERATING INSTRUCTIONS

LIFT AND CARE PROCEDURES

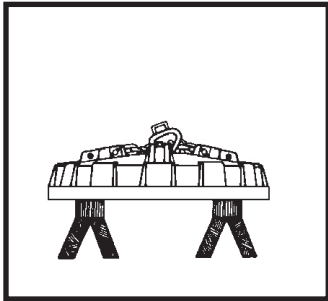

KEEP MAGNET DRY

Always store magnet off of the ground. Never cool the magnet with water. Store in a dry area - moisture can cause short circuits and cripple the lift capacity.

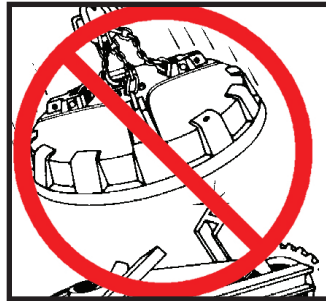

KEEP TERMINAL BOX CLOSED

This keeps moisture away from the terminals and out of the magnet coil.

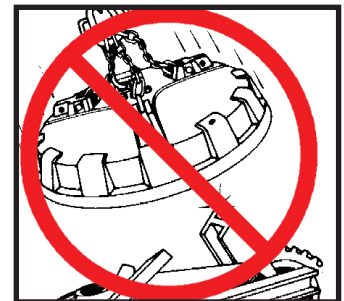

ALWAYS SET MAGNET DOWN EASY

Ease the magnet down onto the load material.



KEEP POWER OFF UNTIL MAGNET SETTLES ON LOAD

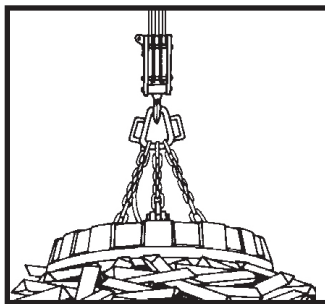

TURN ON POWER - WAIT A FEW SECONDS - THEN LIFT

This lets magnetism build to a peak level for maximum load capacity.

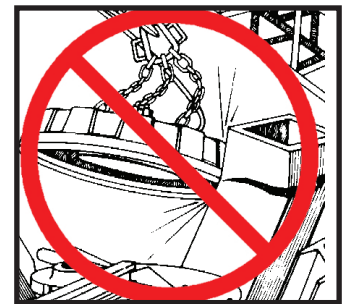

DON'T USE THE MAGNET AS A BATTERING RAM

Improper use, such as dropping a magnet to break up heavy pieces of scrap, will cause damage to the pole shoe, terminal box, or damage the coil. Use the magnet only for lifting.



CAUTION

NEVER re-energize the magnet until it has been placed in contact with the load to be lifted. Prematurely energizing the magnet could cause unwanted materials to be attracted to the magnet or the load to unexpectedly jump to the magnet face.



IMPORTANT FACTS FOR THE OPERATION OF LIFT MAGNETS

LOAD CHARACTERISTICS OTHER THAN JUST WEIGHT MUST BE CONSIDERED IN ORDER TO DETERMINE THE LOAD THAT ANY MAGNET CAN LIFT.

This statement is true for all lifting magnets because they all operate using the same fundamental laws of physics. Magnetic power is often pictured as lines of magnetic force flowing from north pole to south pole. Anything that limits the flow of these magnetic lines of force reduces the magnet's lifting capacity. There are many important factors which limit the flow of these lines of force.

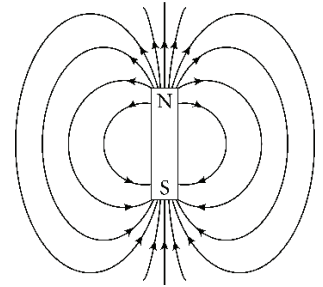

1. LOAD THICKNESS

The greater the number of lines of magnetic force flowing from a magnet into the load, the greater the effectiveness of the magnet. The thicker the load, the more lines of magnetic force are able to flow. Beyond a certain thickness of load, no additional lines of force will flow because the magnet has reached its full capacity.

2. SURFACE CONDITIONS

Magnetic lines of force do not flow easily through air; they need iron in order to flow freely. Therefore, anything that creates a space or an air gap between a magnet and the load limits the flow of magnetic lines of force, and thus reduces the lifting capacity of a magnet.

MAGNET'S LIFTING SURFACE CONDITION — The lifting surfaces of a magnet must be clean, smooth, flat and free of nicks and burrs to minimize the air gap between a magnet and the load. The scrap lift magnets have been designed with soft, low carbon steel lifting surfaces in order to maximize the lifting capacity; special care must be taken to protect these surfaces. Follow the Inspection Instructions in this manual. Do not attach or weld other materials to the lifting surfaces in order to reduce wear because it will reduce the lifting capacity.

3. LOAD ALLOY

Low carbon steels, such as SAE 1020 steel, are nearly as good conductors of magnetic force as pure iron. However, many other alloys contain non-magnetic materials which reduce the ability of magnetic force to flow into the load. An alloy such as SAE 300 series stainless steel is almost as poor a conductor of magnetic force as air.

Type 416 stainless steel is considered magnetic, but it contains enough chromium so that a magnet can develop only one-half as much force on a type 416 stainless steel load as it can on a SAE 1020 steel load.

The force developed on cast iron, because of the carbon content, is less than one-half the force compared with SAE 1020 steel. Chilled cast iron further reduces the force to less than one quarter.



IMPORTANT FACTS FOR THE OPERATION OF LIFT MAGNETS

4. LOAD LENGTH OR WIDTH

As the length or width of a load increases, it ceases to remain flat when lifted and the edges begin to droop. This drooping or sagging of the load can create an air gap between the load and the magnet. This is called peel; if peel occurs, the lifting capacity of the magnet is greatly reduced.

5. POSITION OF MAGNET'S LIFTING SURFACE

As the position of the magnet's lifting surface changes from horizontal to vertical, the lifting capacity of the magnet decreases. When the magnet's lifting surfaces are vertical, the lifting capacity of the magnet is minimized and dependent upon the coefficient of friction between the magnet's lifting surface and the load.

6. PORTION OF MAGNET SURFACE IN CONTACT WITH LOAD

The full surface of the magnet must contact the load if the magnet is to achieve rated lift capacity.

7. LOAD TEMPERATURE

The temperature of the load can cause damage to the magnet. For Standard Scrap Magnets, IMI-Walker should be consulted if the load or air temperature exceeds 110° F (43° C).



TROUBLE SHOOTING



Disconnect power to the magnet before performing any electrical tests on the magnet.

If a lifting magnet is suspected to be faulty, preliminary electrical tests can be made from the external leads. Initial testing should evaluate the power supply, controller, and cable reel assembly.

If tests indicate an open coil, ground or low case to coil resistance, disconnect the cable and connector and make further tests at the coil leads. On some magnets, this will require removal of the terminal box cover.



**Use extreme care when opening a magnet's terminal box.
Contents may be under extreme pressure.
Allow magnet to cool to ambient temperature before opening terminal box**

The magnet can be further checked with the following tests.

MAGNET TEST PROCEDURES



These tests should be performed when the magnet temperature is close to ambient temperature (70° F) and has not been operated for at least 10 hours.

COIL RESISTANCE TEST

1. Use a Wheatstone Bridge, Kelvin, or other accurate ohmmeter (e.g., Fluke 115 or 179).
2. Connect meter leads to terminal junction.
3. Evaluate resistance based on:
 - a) The magnet nameplate
 - b) Calculating the coil resistance by dividing 230 volts by the amps on the nametag ($R=V/I$)
4. If the resistance is lower than a) or b) above, shorted turns are indicated;
If the resistance is less than 75% of this resistance, DO NOT operate magnet! It is likely to cause extreme overheating and may cause serious damage to the coil material.

GROUND INSULATION TEST "MEGGER TEST" (Case to Coil Resistance)

1. Use a 500-volt Megger (e.g., Fluke 1503 or 1507).
2. Connect one Megger lead to terminal junction and the other to a clean surface of the magnet casing.
3. Evaluate resistance readings:
 - a) If the reading is between 20 Megohms and infinity, it is typical of a brand new Walker magnet.
 - b) If the reading is between 10 & 20 Megohms, the insulation is sound.
 - c) If the insulation is between 1 and 10 Megohms, the insulation is still acceptable. However, the insulation has degraded and the magnet should be closely monitored for further deterioration.
 - d) If the reading is less than 1 Megohm, it should be returned to the factory for further inspection.
 - e) Zero Megohms indicates a dead short.

Failure modes: the most common cause of Case-to-Coil Resistance failure is moisture. Once the moisture enters the coil cavity, the coil insulation degrades and permits the current to arc or trace through the moisture to the case.



- a) The terminal box is the most likely moisture entry point - confirm the box has been properly maintained and sealed.
- b) The bottom plate is the second most likely moisture entry point - check to see if the bottom plate has been damaged or the welds have fractured.



TROUBLE SHOOTING (CONTINUED)

AC CURRENT TEST

An accurate test for shorted turns can be made by checking the current that flows through the magnet with a 220 volt 60 cycle power supply connected to the magnet leads.

A good quality ammeter should be used to perform this test.

To establish a value, which can be used in a comparison with future readings, this test should be performed on the magnet upon receipt from the manufacturer.

If provided with the serial number of the magnet, IMI Walker can supply the results of the pre-shipment AC Current Test. Future test readings, which are typically higher than the factory test value, indicate that additional shortened turns are present.

If all tests meet the magnet specifications, troubles can be traced to:

1. Low Voltage
2. Controller Trouble
3. Cable Reel - Ground or Shorts
4. Worn or Broken Cables



LIFTING GUIDELINES AND SPECIFICATIONS

⚠ CAUTION

Each magnet model is rated for a different weight limit. Load characteristics will affect the lifting capacity of the magnets. The lifting guidelines for the various models are shown on the following pages.

- » The Lifting Guidelines tables show the effect of alternate load characteristics on lifting capacity. The rated lifting capacity decreases with alternate load characteristics. The tables show the maximum weight or load size which can be lifted for each type of load.
- » DO NOT EXCEED THE MAXIMUM WEIGHT FOR EACH LOAD TYPE.

SCRAPMASTER and LIFTMASTER

MODEL	Lift Capacity #1 Heavy Melting (lbs)	Lift Capacity #2 Heavy Melting (lbs)	Lift Capacity Turnings (lbs)
SCRAPMASTER D SERIES			
WSMD048B41	1750	1160	600
WSMD057B41	2700	1800	850
WSMD066B41	4100	2750	1350
WSMD072B41	4700	3150	1500
SCRAPMASTER DISH SERIES			
WSMH045B41	1500	1030	480
WSMH054B41	2560	1660	730
WSMH063B41	3970	2580	1230
WSMH069B41	4520	3000	1360
LIFTMASTER SERIES			
WLM030B41	450	300	125
WLM040B41	1150	680	360

ADDITIONAL OPERATING INFORMATION

Avoid dropping, banging, or slamming the magnet into other objects.

These lifting magnets are electromagnetic devices. Do not allow water to enter the magnet body.

DO NOT EXCEED THE RATED 50% DUTY CYCLE OF THESE MAGNETS.

Exceeding the duty cycle will result in reduced lifting capacity and a shorter magnet life. Refer to Page 14 for definition of Duty Cycle.

⚠ WARNING	If there is any difficulty lifting a load, DON'T LIFT IT! Call Walker Magnetics for advice at 1-800-962-4638
------------------	---



DUTY CYCLE

DUTY CYCLE

DO NOT EXCEED THE RATED 50% DUTY CYCLE OF THESE MAGNETS.

Exceeding the duty cycle will result in reduced lifting capacity, and a shorter magnet life.

Duty cycle rating is defined as:

$$\text{Duty Cycle \%} = (\text{Time On} \times 100) \div (\text{Time Off} + \text{Time On})$$

EXAMPLES:

3 MINUTES ON, 1 MINUTE OFF: $(3 \times 100) \div (3 + 1) = 75\%$

5 MINUTES ON, 5 MINUTES OFF: $(5 \times 100) \div (5 + 5) = 50\%$



Maximum time on is specified as 10 minutes

To maximize the effectiveness of the magnet, keep the power off when the magnet is not in use.

PARTS LIST

Item	Description
1	Magnet case
2	Lift pin
3	Terminal box cover
4	Chain sling
5	Electric connection terminal

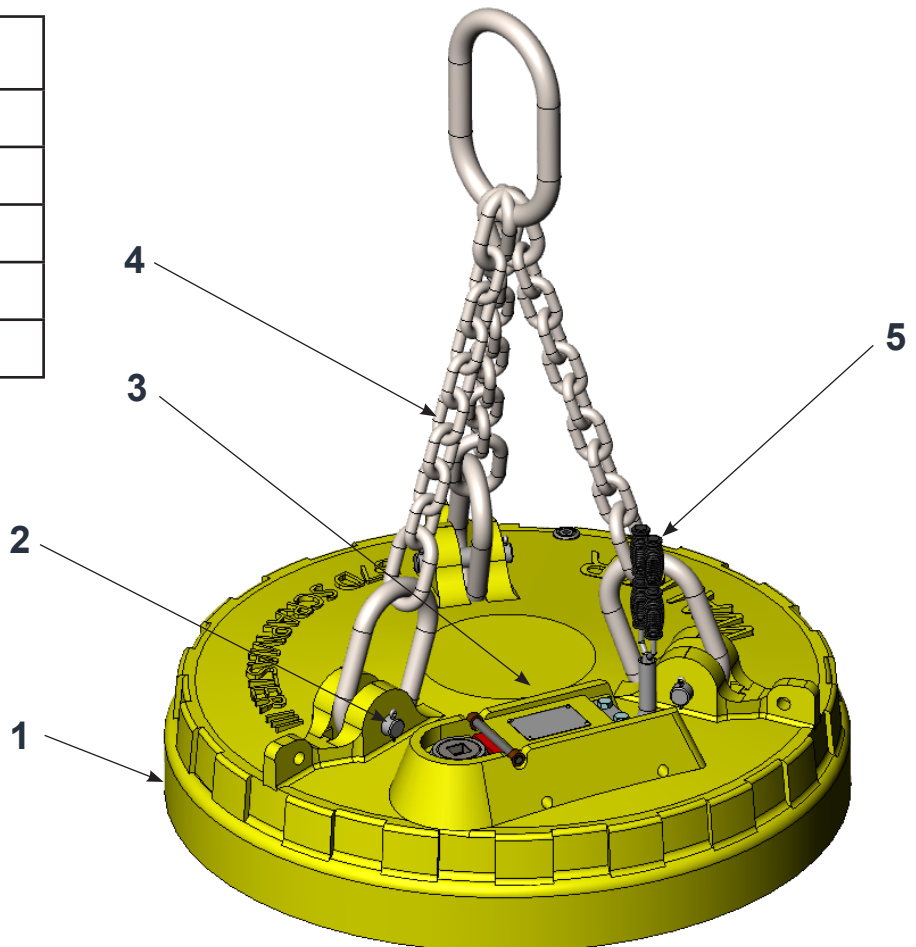



INSPECTION AND MAINTENANCE INSTRUCTIONS



Turn off or disconnect electric power for all inspection and maintenance activity.

EVERY LIFT

- » Keep the lifting surfaces of the magnet CLEAN, SMOOTH, FLAT, FREE OF RUST and any FOREIGN MATERIALS. Nicks and burrs on the lifting surfaces will reduce the lifting capacity. If burrs occur, they can be removed by filing them away. However, care must be taken to protect the neighboring lifting surfaces.
- » Deep nicks may require regrinding of the entire lifting surfaces (See Weekly Inspection below)

DAILY

- » Check the entire magnet case, lifting surfaces, bail or eyebolts, and welds for cracks or other defects. If present, remove the unit from service and contact a Qualified Person or IMI Walker Magnetics.
- » All chain links and chain pins should be checked for wear; check the eyebolt or lift bail for wear. If chain component or lift bail is worn to less than 90% of its original dimension, it should be removed from service and replaced.
- » Insure that cotter pins, plates, washers, etc. are in place and in good condition.
- » Check physical condition of power cord and any lamp or switch. Look for cuts, abrasion and strain damage. Repair or replace any suspicious components. Check that the twist lock type electric connector is securely attached to the electrical receptacle.
- » Check the condition of the Operating Instruction label and Product Safety signs. The magnet was supplied with Lifting Guidelines/ Operating Instruction and Product Safety sign labels. If these labels and signs are missing or damaged, they should be replaced.

WEEKLY

The lifting surfaces of the magnet should be checked for flatness and wear. Uneven wear and out of flatness can greatly reduce the lifting capacity because it will cause a non-magnetic separation (air gap) between the magnet and the surface of the load. Some nicks and burrs will occur on the lifting surfaces due to normal usage. When the flat contact area of the entire magnet's lifting surfaces becomes less than 90% of the original total lifting surface, it should be taken out of service until the lifting surfaces are reground.*

*Regrinding the lifting surfaces.

Regrinding may be necessary to insure that all the lifting surfaces remain flat and in the same plane. After regrinding, the magnet must be re-tested for breakaway force in accordance with ANSI/ASME B30.20.

IMI Walker Magnetics recommends that lifting magnets be re-tested for breakaway force each year.

Completely inspect and **record** the condition of the magnet and its suspension system and maintain this record. Test and record the magnet's coil resistance, case to coil resistance and AC current test reading. This will provide a health status of the magnet's internal insulation when compared with values taken when the magnet was put in service.



REPAIRS

For repair of a Scrap Lifting magnet, contact IMI Walker Magneticon for the nearest Authorized Service Center TOLL FREE at 1-800-W-MAGNET.

A return material authorization number will be issued along with the address of the nearest Service Center. The magnet, after receipt by the Service Center, will be inspected and an estimate of repair charges will be provided.

Authorization for repairs from magnet owners must be given to the IMI Walker Magneticon Service Center before repairs are made. Transportation charges, both to and from the factory, are to be paid by the magnet owner.

⚠ WARNING

- » Disassembly or repair of this magnet can result in reduced holding power and/or cause an unsafe condition. Anytime the magnet is disassembled beyond the parts list shown in this manual, the magnet must be re-tested for breakaway force in accordance with the test described in ANSI/ASME B30.20.
- » Modification of any operating mechanism or structure of this magnet can reduce the magnet's effectiveness and/or cause unsafe conditions.
- » Repair or modification of this magnet should only be performed by Walker Magneticon.*

* Walker replacement parts may be installed by a **Designated Person.

** Designated Person: A person selected or assigned by the employer as being competent to replace specific replacement parts listed in this manual and is able to verify the proper functioning of the specific replacement parts and the entire product after the completion of the installation.

**This product is manufactured in accordance with ASME B30.20
For further information, refer to Chapter 20-3 Close Proximity Operated Lifting Magnets**

FOR FAST RESPONSE, CALL 1-800-W-MAGNET

COMMENTS OR CONCERNS?

We believe Industrial Magneticon, Inc. offers the finest Scrap Lifting Magnets available today. Great pride has gone into the design and manufacture of this unit. Any comments or concerns should be directed to our Customer Service Department at 1-888-582-0822.

We appreciate the opportunity to serve you!